

HBJ-10 CE Positioner 1 Tonne Load Capacity

HB Series positioner provide 360° rotation of a work piece along with 0- 90° forward tilt to better position weldments for better down-hand or automatic welding. All-fabricated steel frames and bases support rotation with heavy bearings driven by worm-gear reducers to provide enhanced safety and durability. Powered rotation is controlled via push-button pendant for controlling variable-speed table rotation, and forward/stop/reverse table direction/emergency-stop controls. Rotation motor is inverter-controlled variable-frequency AC-type, providing a full range of variable-speed control with excellent speed-regulation. Tilting motor with brake. Control boxes have IP55 rated enclosures and utilize variable frequency AC control electrical systems with full CE certification. In addition, our company has certified by ISO 9001:2015 Quality Management System to ensure all our products establish safe working loads in the weld automation industry.

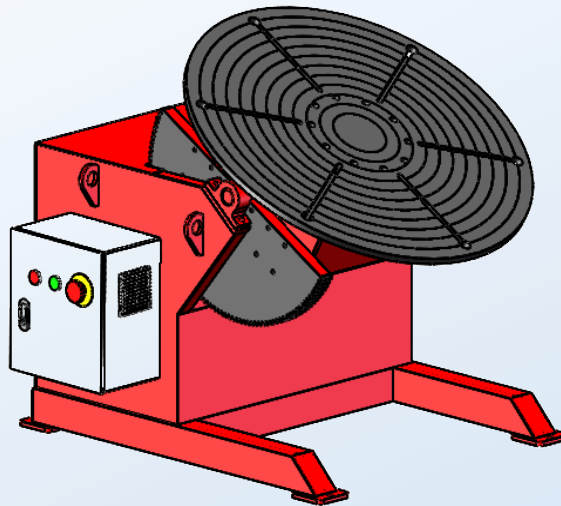

Specifications

Model	HBJ-10 Positioner	Tilting motor	1.5 kw with brake
Turning Capacity	1000kg maximum	Tilting speed	0.55 rpm
Table diameter	1200 mm	Tilting torque	4600 N.m
Rotation motor	0.75 kw	Voltage	380V ± 10% 50Hz 3Phase
Rotation speed	0.12-1.2 rpm Variable	Control system	Remote control 8m cable
Rotation torque	2500 N.m	Color	RAL 3003 RED+9005 Black
Tilting angle	0-90 degree	Options	3 jaw chucks available

*Specifications are subject to change without notice.

Add: Unit 4 Midland Distribution Center, Markfield Road, Groby, Leicestershire, LE6 OFS, U.K.

HBJ-10 CE Positioner

1 Tonne Load Capacity

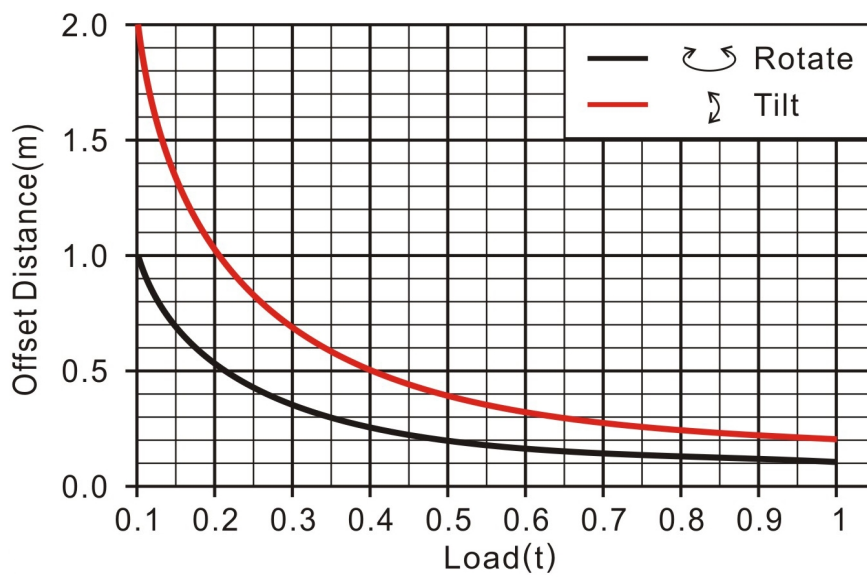
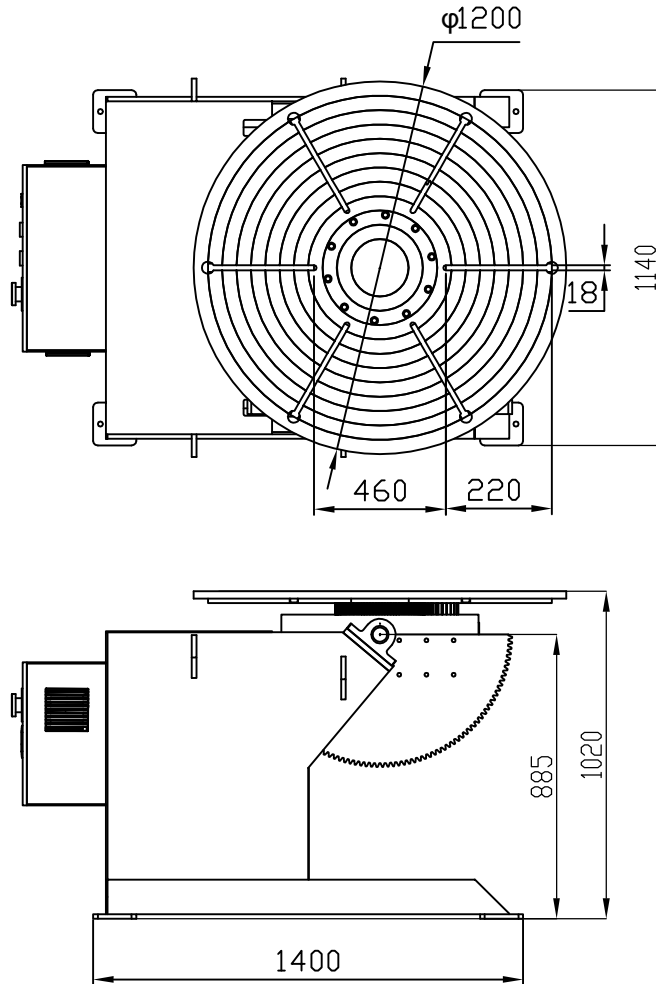

*Specifications are subject to change without notice.